

LM4816 Boomer® Audio Power Amplifier Series

1W Stereo Audio Amplifier + Adjustable Output Limiter

General Description

The LM4816 combines a bridged-connected (BTL) stereo audio power amplifier with an adjustable output voltage magnitude limiter. The audio amplifier delivers 1.0W to an 8Ω load with less than 1.0% THD+N while operating on a 5V power supply. With V_{LIM} set to 1.0V, the amplifier outputs are clamped to $6V_{p-p}$, $\pm 800mV$.

The LM4816 features an external controlled micropower shutdown mode and thermal shutdown protection. It also utilizes circuitry that reduces "clicks and pops" during device turn-on and return from shutdown.

Boomer audio power amplifiers are designed specifically to use few external components and provide high quality output power in a surface mount package.

Key Specifications

■ P_{OUT} (BTL):	$V_{DD} = 5V$, THD = 1%, $R_L = 8\Omega$	1.0W (typ)
■ Power supply range		3.0V to 5.5V
■ Limiter adjustment range		GND to $V_{DD}/2$
■ Shutdown current		0.06μA (typ)

Features

- Stereo BTL amplifier
- Adjustable output voltage magnitude limiter
- "Click and pop" suppression circuitry
- Unity-gain stable audio amplifiers
- Thermal shutdown protection circuitry
- TSSOP (MT) package

Applications

- Notebook computers
- Multimedia monitors
- Desktop computers
- Portable televisions

Typical Application

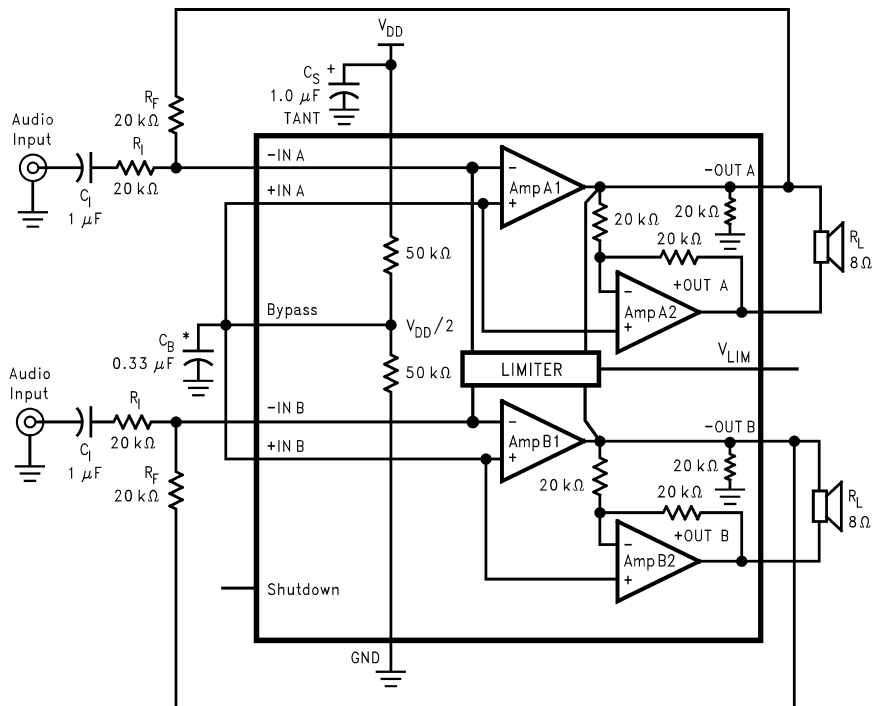

20033201

Boomer® is a registered trademark of National Semiconductor Corporation.

Connection Diagram

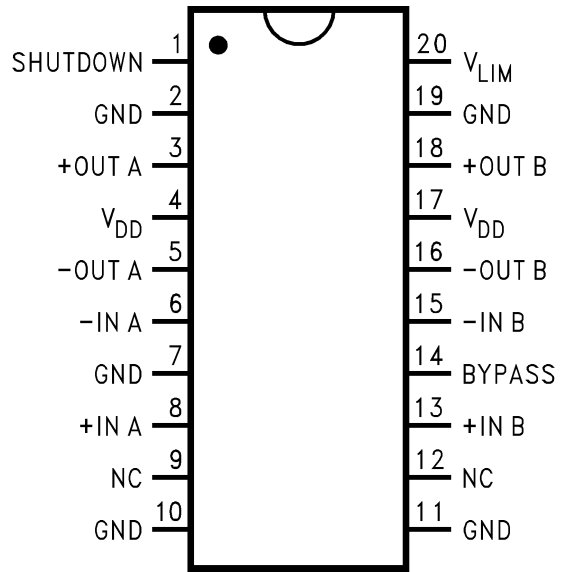

20033229

Top View
 Order Number LM4816MT
 See NS Package Number MTC20 for TSSOP

Absolute Maximum Ratings (Note 1)

If Military/Aerospace specified devices are required, please contact the National Semiconductor Sales Office/Distributors for availability and specifications.

Supply Voltage	6.0V
Storage Temperature	-65°C to +150°C
Input Voltage	-0.3V to V_{DD} +0.3V
Power Dissipation (Note 2)	Internally limited
ESD Susceptibility (Note 3)	2000V
ESD Susceptibility (Note 4)	200V
Junction Temperature	150°C
Solder Information	
Small Outline Package	

Vapor Phase (60 sec.) 215°C

Infrared (15 sec.) 220°C

See AN-450 "Surface Mounting and their Effects on Product Reliability" for other methods of soldering surface mount devices.

Thermal Resistance		
θ_{JC} (typ) — MTC20		20°C/W
θ_{JA} (typ) — MTC20		80°C/W

Operating Ratings

Temperature Range		
$T_{MIN} \leq T_A \leq T_{MAX}$		-40°C $\leq T_A \leq$ 85°C
Supply Voltage		3.0V $\leq V_{DD} \leq$ 5.5V

Electrical Characteristics (Notes 1, 5)

The following specifications apply for $V_{DD} = 5V$ unless otherwise specified. Limits apply for $T_A = 25^\circ C$.

Symbol	Parameter	Conditions	LM4816		Units (Limits)
			Typical (Note 6)	Limit (Note 7)	
V_{DD}	Supply Voltage			3.0	V (min)
				5.5	V (max)
I_{DD}	Quiescent Power Supply Current	$V_{IN} = 0V, I_O = 0A$ (Note 8)	9.0	15	mA (max)
				5	mA (min)
I_{SD}	Shutdown Current	V_{DD} applied to the SHUTDOWN pin	0.06	2	μA (min)
V_{IH}	Shutdown Logic High Input Threshold Voltage			3.0	V (min)
V_{IL}	Shutdown Logic Low Input Threshold Voltage			1.8	V (max)
V_{OS}	Output Offset Voltage	$V_{IN} = 0V$	5	50	mV (max)
P_O	Output Power (Note 9)	THD+N = 1%, $f = 1kHz, R_L = 8\Omega$	1.0	0.9	W (min)
		THD+N = 10%, $f = 1kHz, R_L = 8\Omega$	1.5		W
THD+N	Total Harmonic Distortion + Noise	20Hz $\leq f \leq$ 20kHz, $A_{VD} = 2$ $R_L = 8\Omega, P_O = 400mW$	0.03		%
V_{LIM}	Limiter Clamp Voltage	$V_{LIM} = 1.0V, R_L = \infty, V_{IN} = 4V_{P-P}$ $V_{O P-P} = (V_{OUT+} - V_{OUT-})$	6.0	5.2	V_{P-P} (min)
				6.8	V_{P-P} (max)
PSRR	Power Supply Rejection ratio	$V_{DD} = 5V, V_{RIPPLE} = 200V_{RMS}$ $R_L = 8\Omega, C_B = 1.0\mu F$ Inputs Floating Inputs terminated with 10 Ω	67 43		dB dB
X_{TALK}	Channel Separation	$f = 1kHz, C_B = 1.0\mu F$	90		dB
SNR	Signal to Noise Ratio	$V_{DD} = 5V, P_O = 1.0W, R_L = 8\Omega$	98		dB

Note 1: Absolute Maximum Ratings indicate limits beyond which damage to the device may occur. Operating Ratings indicate conditions for which the device is functional, but do not guarantee specific performance limits. Electrical Characteristics state DC and AC electrical specifications under particular test conditions which guarantee specific performance limits. This assumes that the device is within the Operating Ratings. Specifications are not guaranteed for parameters where no limit is given, however, the typical value is a good indication of device performance.

Note 2: The maximum power dissipation is dictated by T_{JMAX} , θ_{JA} , and the ambient temperature T_A and must be derated at elevated temperatures. The maximum allowable power dissipation is $P_{DMAX} = (T_{JMAX} - T_A)/\theta_{JA}$. For the LM4816, $T_{JMAX} = 150^\circ C$. For the θ_{JA} s for different packages, please see the Application Information section or the Absolute Maximum Ratings section.

- Note 3:** Human body model, 100pF discharged through a 1.5kΩ resistor.
- Note 4:** Machine model, 220pF–240pF discharged through all pins.
- Note 5:** All voltages are measured with respect to the ground (GND) pins unless otherwise specified.
- Note 6:** Typical values are measured at 25°C and represent the parametric norm.
- Note 7:** Datasheet min/max specification limits are guaranteed by design, test, or statistical analysis.
- Note 8:** The quiescent power supply current depends on the offset voltage when a practical load is connected to the amplifier.
- Note 9:** Output power is measured at the device terminals.

Typical Performance Characteristics

THD+N vs Frequency

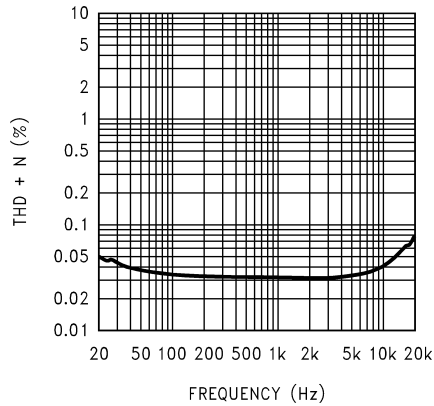

$V_{DD} = 5V, R_L = 8\Omega, P_{OUT} = 150mW$

THD+N vs Output Power

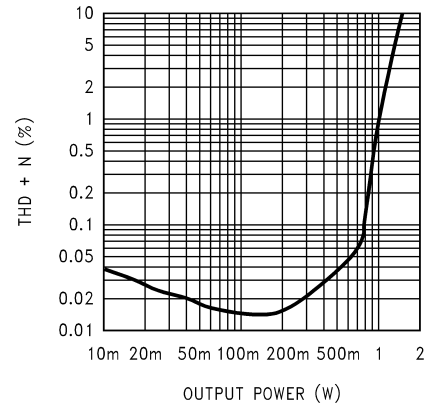

$V_{DD} = 5V, R_L = 8\Omega, f_{IN} = 1kHz$

THD+N vs Frequency

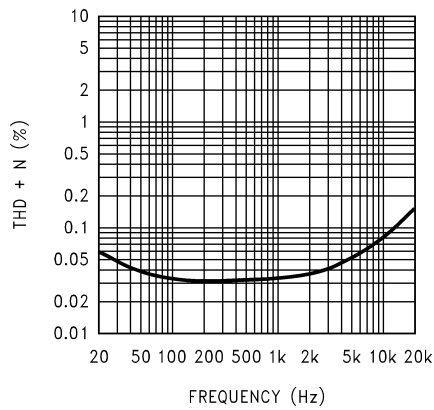

$V_{DD} = 3V, R_L = 8\Omega, P_{OUT} = 150mW$

THD+N vs Output Power

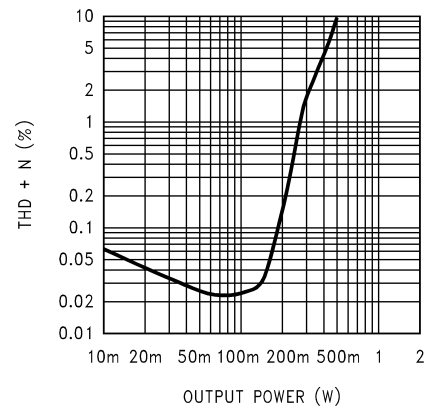

$V_{DD} = 3V, R_L = 8\Omega, f_{IN} = 1kHz$

Typical Performance Characteristics (Continued)

THD+N vs Frequency

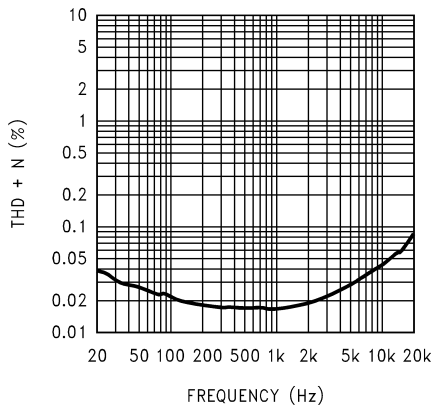

20033266
 $V_{DD} = 5.5V, R_L = 8\Omega, P_{OUT} = 150mW$

THD+N vs Output Power

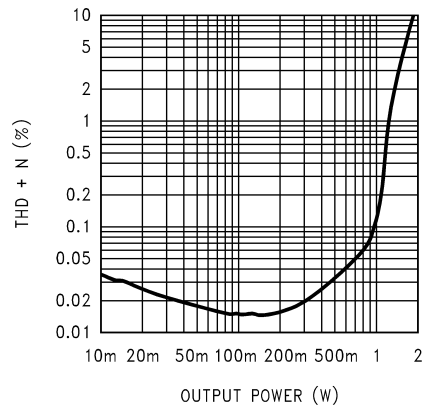

20033295
 $V_{DD} = 5.5V, R_L = 8\Omega, f_{IN} = 1kHz$

THD+N vs Output Power

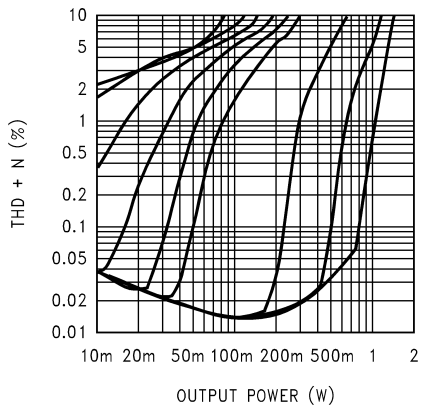

20033264
 $V_{DD} = 5V, R_L = 8\Omega, f_{IN} = 1kHz,$
 at (from left to right at 7% THD+N):
 $V_{LIM} = 2V, 1.9V, 1.8V, 1.7V, 1.6V, 1.5V, 1.0V, 0.5V, 0V$

PSRR vs Frequency

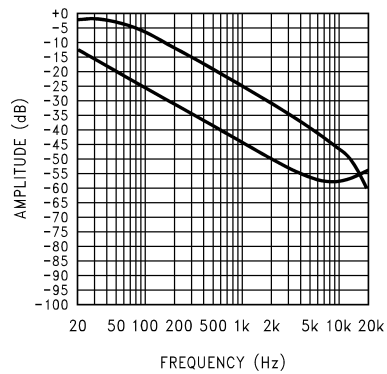

20033242
 $V_{DD} = 5V, R_L = 8\Omega, R_{SOURCE} = 10\Omega,$
 $V_{RIPPLE} = 200mV_{P-P},$ at (from top to bottom at 500Hz):
 $C_{BYPASS} = 0.1\mu F, C_{BYPASS} = 1.0\mu F$

PSRR vs Frequency

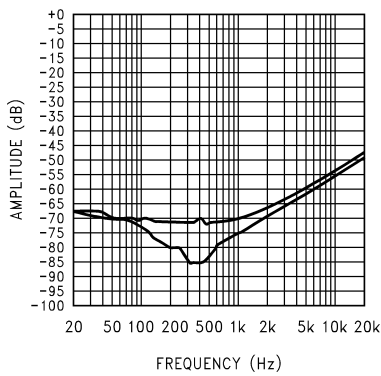

20033243
 $V_{DD} = 5V, R_L = 8\Omega, R_{SOURCE} = \infty,$
 $V_{RIPPLE} = 200mV_{P-P},$ at (from top to bottom at 500Hz):
 $C_{BYPASS} = 0.1\mu F, C_{BYPASS} = 1.0\mu F$

PSRR vs Frequency

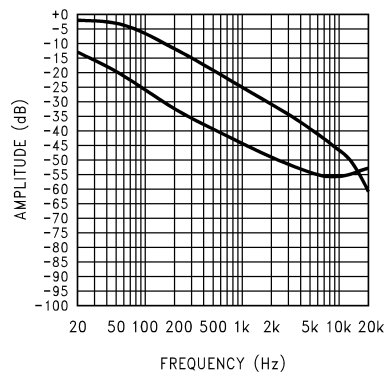

20033240
 $V_{DD} = 3V, R_L = 8\Omega, R_{SOURCE} = 10\Omega,$
 $V_{RIPPLE} = 200mV_{P-P},$ at (from top to bottom at 500Hz):
 $C_{BYPASS} = 0.1\mu F, C_{BYPASS} = 1.0\mu F$

Typical Performance Characteristics (Continued)

PSRR vs Frequency

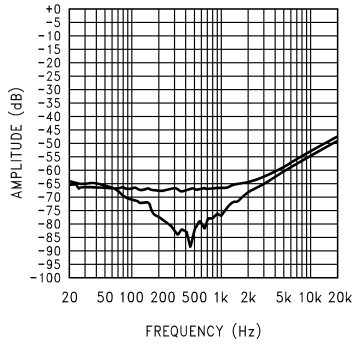

20033241

$V_{DD} = 3V, R_L = 8\Omega, R_{SOURCE} = \infty,$
 $V_{RIPPLE} = 200mV_{P-P},$ at (from top to bottom at 500Hz):
 $C_{BYPASS} = 0.1\mu F, C_{BYPASS} = 1.0\mu F$

Cross Talk

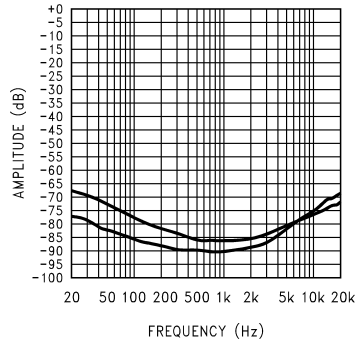

20033239

$V_{DD} = 5V, R_L = 8\Omega, P_{OUT} = 150mW,$ at (from top to bottom at 2kHz):
 -N A driven, V_{OUTB} measured;
 -N B driven, V_{OUTA} measured

Cross Talk

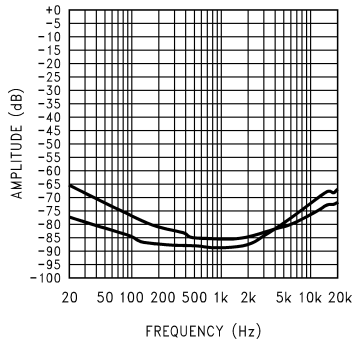

20033237

$V_{DD} = 3V, R_L = 8\Omega, P_{OUT} = 150mW,$ at (from top to bottom at 2kHz):
 -N A driven, V_{OUTB} measured;
 -N B driven, V_{OUTA} measured

Cross Talk

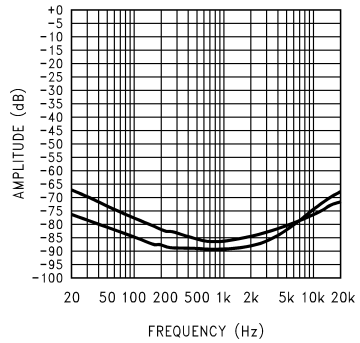

20033238

$V_{DD} = 5.5V, R_L = 8\Omega, P_{OUT} = 150mW,$ at (from top to bottom at 2kHz):
 -N A driven, V_{OUTB} measured;
 -N B driven, V_{OUTA} measured

Supply Current vs Supply Voltage

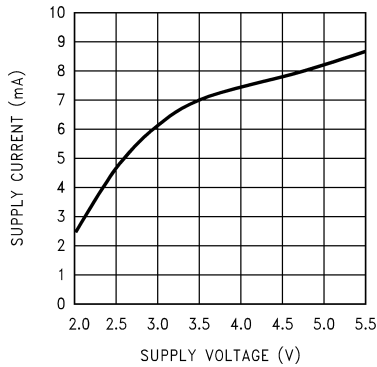

20033253

$R_L = 8\Omega, V_{IN} = 0V$
 $R_{SOURCE} = 50\Omega$

Output Power vs Supply Voltage

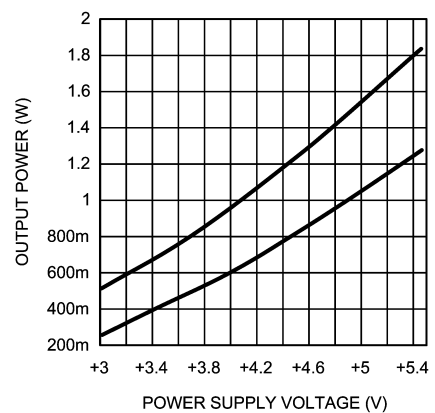

20033230

$R_L = 8\Omega, f_{IN} = 1kHz,$ at (from top to bottom at 4.6V):
 $THD+N = 10\%, THD+N = 1\%$

Typical Performance Characteristics (Continued)

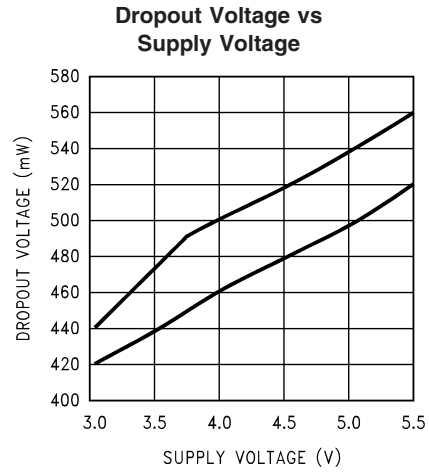
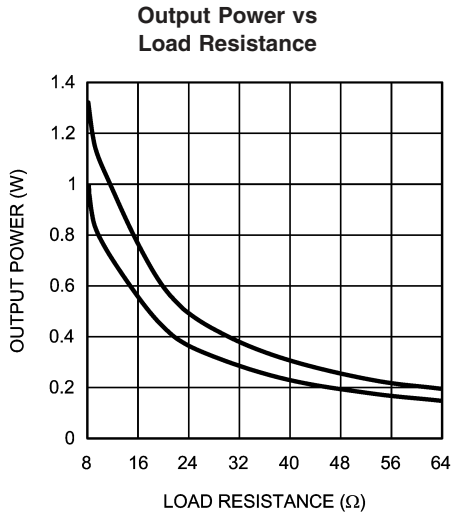

20033257
 $V_{DD} = 5V$, $f_{IN} = 1kHz$, at (from top to bottom at 32 Ω):
 THD+N = 10%, THD+N = 1%

20033255
 $R_L = 8\Omega$, $f_{IN} = 1kHz$, at (from top to bottom at 4.5V):
 positive signal swing, negative signal swing

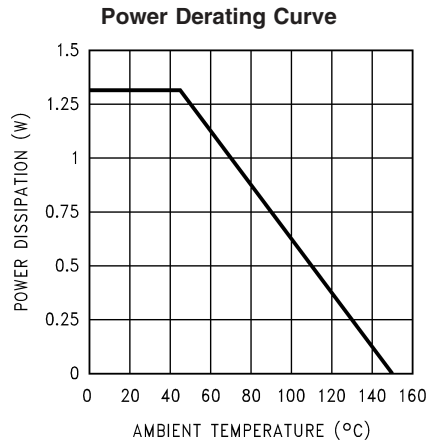
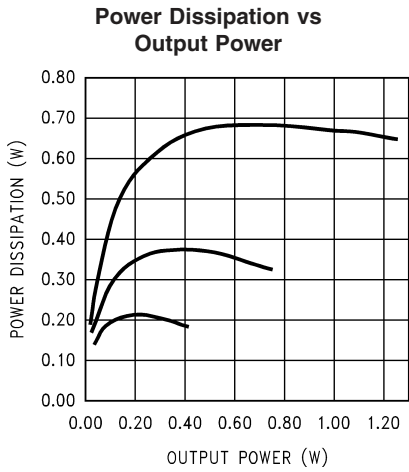

20033252
 $V_{DD} = 5V$, $f_{IN} = 1kHz$, at (from top to bottom at 0.20W):
 $R_L = 8\Omega, 16\Omega, 32\Omega$

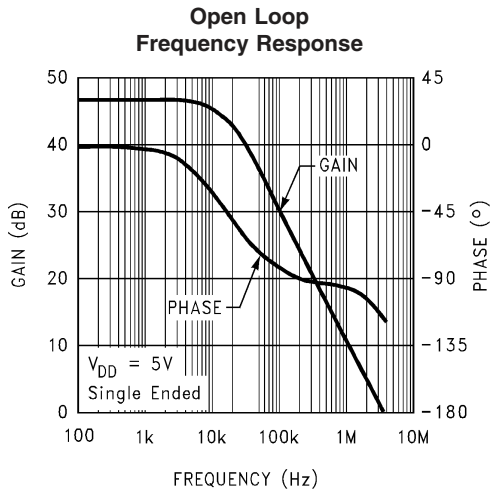

20033222

External Components Description

(Refer to Figure 1.)

Components	Functional Description
1. R_i	The Inverting input resistance, along with R_f , set the closed-loop gain. R_i , along with C_i , form a high pass filter with $f_c = 1/(2\pi R_i C_i)$.
2. C_i	The input coupling capacitor blocks DC voltage at the amplifier's input terminals. C_i , along with R_i , create a highpass filter with $f_c = 1/(2\pi R_i C_i)$. Refer to the section, SELECTING PROPER EXTERNAL COMPONENTS , for an explanation of determining the value of C_i .
3. R_f	The feedback resistance, along with R_i , set the closed-loop gain.
4. C_s	The supply bypass capacitor. Refer to the POWER SUPPLY BYPASSING section for information about properly placing, and selecting the value of, this capacitor.
5. C_B	The capacitor, C_B , filters the half-supply voltage present on the BYPASS pin. Refer to the SELECTING PROPER EXTERNAL COMPONENTS section for information concerning proper placement and selecting C_B 's value.

Application Information

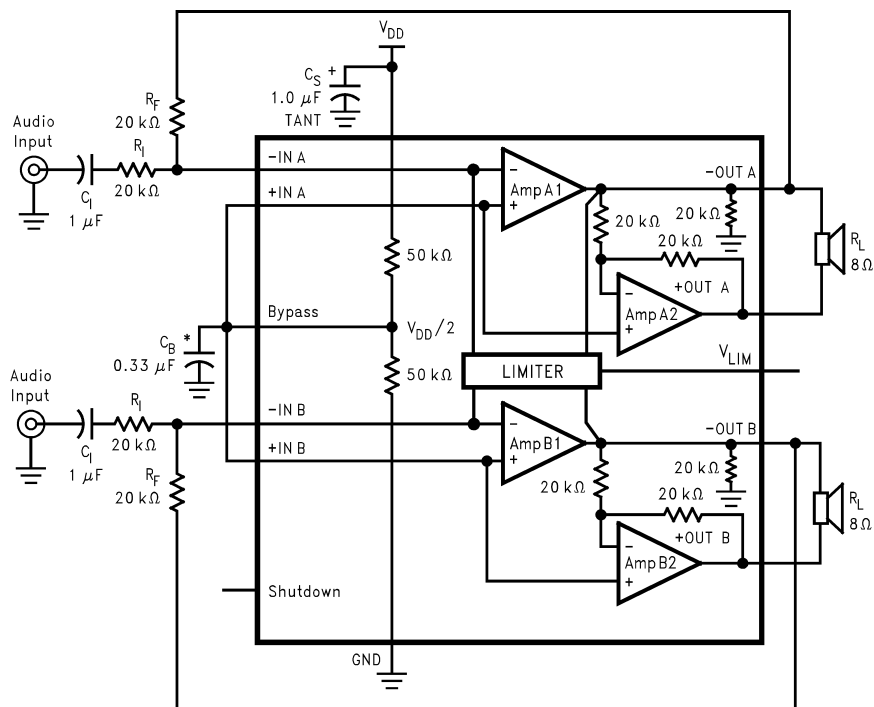

20033201

* Refer to the section Proper Selection of External Components, for a detailed discussion of C_B size.

FIGURE 1. Typical Audio Amplifier Application Circuit
Pin out shown for the LLP package. Refer to the Connection Diagrams for the pinout of the TSSOP package.

Application Information (Continued)

BRIDGE CONFIGURATION EXPLANATION

As shown in *Figure 1*, the LM4816 consists of two pairs of operational amplifiers, forming a two-channel (channel A and channel B) stereo amplifier. (Though the following discusses channel A, it applies equally to channel B.) External resistors R_f and R_i set the closed-loop gain of Amp1A, whereas two internal 20k Ω resistors set Amp2A's gain at -1. The LM4816 drives a load, such as a speaker, connected between the two amplifier outputs, -OUTA and +OUTA.

Figure 1 shows that Amp1A's output serves as Amp2A's input. This results in both amplifiers producing signals identical in magnitude, but 180° out of phase. Taking advantage of this phase difference, a load is placed between -OUTA and +OUTA and driven differentially (commonly referred to as "bridge mode"). This results in a differential gain of

$$A_{VD} = 2 \times (R_f / R_i) \quad (1)$$

Bridge mode amplifiers are different from single-ended amplifiers that drive loads connected between a single amplifier's output and ground. For a given supply voltage, bridge mode has a distinct advantage over the single-ended configuration: its differential output doubles the voltage swing across the load. This produces four times the output power when compared to a single-ended amplifier under the same conditions. This increase in attainable output power assumes that the amplifier is not current limited or that the output signal is not clipped. To ensure minimum output signal clipping when choosing an amplifier's closed-loop gain, refer to the **Audio Power Amplifier Design** section.

Another advantage of the differential bridge output is no net DC voltage across the load. This is accomplished by biasing channel A's and channel B's outputs at half-supply. This eliminates the coupling capacitor that single supply, single-ended amplifiers require. Eliminating an output coupling capacitor in a single-ended configuration forces a single-supply amplifier's half-supply bias voltage across the load. This increases internal IC power dissipation and may permanently damage loads such as speakers.

POWER DISSIPATION

Power dissipation is a major concern when designing a successful single-ended or bridged amplifier. Equation (2) states the maximum power dissipation point for a single-ended amplifier operating at a given supply voltage and driving a specified output load

$$P_{DMAX} = (V_{DD})^2 / (2\pi^2 R_L) \text{ Single-Ended} \quad (2)$$

However, a direct consequence of the increased power delivered to the load by a bridge amplifier is higher internal power dissipation for the same conditions.

The LM4816 has two operational amplifiers per channel. The maximum internal power dissipation per channel operating in the bridge mode is four times that of a single-ended amplifier. From Equation (3), assuming a 5V power supply and an 8 Ω load, the maximum single channel power dissipation is 0.633W or 1.27W for stereo operation.

$$P_{DMAX} = 4 \times (V_{DD})^2 / (2\pi^2 R_L) \text{ Bridge Mode} \quad (3)$$

The LM4816's power dissipation is twice that given by Equation (2) or Equation (3) when operating in the single-ended mode or bridge mode, respectively. Twice the maximum power dissipation point given by Equation (3) must not exceed the power dissipation given by Equation (4):

$$P_{DMAX}' = (T_{JMAX} - T_A) / \theta_{JA} \quad (4)$$

The LM4816's $T_{JMAX} = 150^\circ\text{C}$. In the MT (TSSOP) package, the LM4816's θ_{JA} is 80°C/W. At any given ambient temperature T_{JA} , use Equation (4) to find the maximum internal power dissipation supported by the IC packaging. Rearranging Equation (4) and substituting P_{DMAX} for P_{DMAX}' results in Equation (5). This equation gives the maximum ambient temperature that still allows maximum stereo power dissipation without violating the LM4816's maximum junction temperature.

$$T_A = T_{JMAX} - 2 \times P_{DMAX} \theta_{JA} \quad (5)$$

For a typical application with a 5V power supply and an 8 Ω load, the maximum ambient temperature that allows maximum stereo power dissipation without exceeding the maximum junction temperature is approximately 48°C.

$$T_{JMAX} = P_{DMAX} \theta_{JA} + T_A \quad (6)$$

Equation (6) gives the maximum junction temperature T_{JMAX} . If the result violates the LM4816's 150°C, reduce the maximum junction temperature by reducing the power supply voltage or increasing the load resistance. Further allowance should be made for increased ambient temperatures.

The above examples assume that a device is a surface mount part operating around the maximum power dissipation point. Since internal power dissipation is a function of output power, higher ambient temperatures are allowed as output power or duty cycle decreases.

If twice the value given by Equation (3) exceeds the value given by Equation (4), then decrease the supply voltage, increase the load impedance, or reduce the ambient temperature.

OUTPUT VOLTAGE LIMITER

The LM4816's adjustable output voltage limiter can be used to set a maximum and minimum output voltage swing magnitude. The voltage applied to the V_{LIM} input (pin 20) controls the amount voltage limit magnitude.

Without the limiter's influence ($V_{LIM} = 0V$), the LM4816's maximum BTL output swing is nominally

$$2 \times V_{DD}$$

When the limiter input voltage is greater than 0V, the BTL output voltage swing is

$$V_{OUT-BTL} = (2 \times V_{DD}) - (4 \times V_{LIM})$$

with a tolerance of ± 800 mV.

POWER SUPPLY BYPASSING

As with any power amplifier, proper supply bypassing is critical for low noise performance and high power supply rejection. Applications that employ a 5V regulator typically use a 10 μF in parallel with a 0.1 μF filter capacitors to stabilize the regulator's output, reduce noise on the supply line, and improve the supply's transient response. However, their

Application Information (Continued)

presence does not eliminate the need for a local 1.0 μ F tantalum bypass capacitance connected between the LM4816's supply pins and ground. Do not substitute a ceramic capacitor for the tantalum. Doing so may cause oscillation in the output signal. Keep the length of leads and traces that connect capacitors between the LM4816's power supply pin and ground as short as possible. Connecting a 1 μ F capacitor, C_B , between the BYPASS pin and ground improves the internal bias voltage's stability and improves the amplifier's PSRR. The PSRR improvements increase as the bypass pin capacitor value increases. Too large, however, increases turn-on time and can compromise amplifier's click and pop performance. The selection of bypass capacitor values, especially C_B , depends on desired PSRR requirements, click and pop performance (as explained in the section, **Proper Selection of External Components**), system cost, and size constraints.

MICRO-POWER SHUTDOWN

The voltage applied to the SHUTDOWN pin controls the LM4816's shutdown function. Activate micro-power shutdown by applying V_{DD} to the SHUTDOWN pin. When active, the LM4816's micro-power shutdown feature turns off the amplifier's bias circuitry, reducing the supply current. The logic threshold is typically $V_{DD}/2$. The low 0.6 μ A typical shutdown current is achieved by applying a voltage that is as near as V_{DD} as possible to the SHUTDOWN pin. A voltage that is less than V_{DD} may increase the shutdown current.

There are a few ways to control the micro-power shutdown. These include using a single-pole, single-throw switch, a microprocessor, or a microcontroller. When using a switch, connect an external 10k Ω pull-up resistor between the SHUTDOWN pin and V_{DD} . Connect the switch between the SHUTDOWN pin and ground. Select normal amplifier operation by closing the switch. Opening the switch connects the SHUTDOWN pin to V_{DD} through the pull-up resistor, activating micro-power shutdown. The switch and resistor guarantee that the SHUTDOWN pin will not float. This prevents unwanted state changes. In a system with a microprocessor or a microcontroller, use a digital output to apply the control voltage to the SHUTDOWN pin. Driving the SHUTDOWN pin with active circuitry eliminates the pull up resistor.

TABLE 1. LOGIC LEVEL TRUTH TABLE FOR SHUTDOWN OPERATION

SHUTDOWN	OPERATIONAL MODE
Low	Full power, stereo BTL amplifiers
High	Micro-power Shutdown

SELECTING PROPER EXTERNAL COMPONENTS

Optimizing the LM4816's performance requires properly selecting external components. Though the LM4816 operates well when using external components with wide tolerances, best performance is achieved by optimizing component values.

The LM4816 is unity-gain stable, giving a designer maximum design flexibility. The gain should be set to no more than a given application requires. This allows the amplifier to achieve minimum THD+N and maximum signal-to-noise ratio. These parameters are compromised as the closed-loop gain increases. However, low gain demands input signals with greater voltage swings to achieve maximum output

power. Fortunately, many signal sources such as audio CODECs have outputs of 1V_{RMS} (2.83V_{P-P}). Please refer to the **Audio Power Amplifier Design** section for more information on selecting the proper gain.

Input Capacitor Value Selection

Amplifying the lowest audio frequencies requires high value input coupling capacitor (C_i in *Figure 1*). A high value capacitor can be expensive and may compromise space efficiency in portable designs. In many cases, however, the speakers used in portable systems, whether internal or external, have little ability to reproduce signals below 150Hz. Applications using speakers with this limited frequency response reap little improvement by using large input capacitor.

Besides effecting system cost and size, C_i has an affect on the LM4816's click and pop performance. When the supply voltage is first applied, a transient (pop) is created as the charge on the input capacitor changes from zero to a quiescent state. The magnitude of the pop is directly proportional to the input capacitor's size. Higher value capacitors need more time to reach a quiescent DC voltage (usually $V_{DD}/2$) when charged with a fixed current. The amplifier's output charges the input capacitor through the feedback resistor, R_f . Thus, pops can be minimized by selecting an input capacitor value that is no higher than necessary to meet the desired -3dB frequency.

As shown in *Figure 1*, the input resistor (R_i) and the input capacitor, C_i produce a -3dB high pass filter cutoff frequency that is found using Equation (7).

$$f_{-3\text{ dB}} = \frac{1}{2\pi R_{IN} C_i} \quad (7)$$

As an example when using a speaker with a low frequency limit of 150Hz, C_i , using Equation (4), is 0.063 μ F. The 1.0 μ F C_i shown in *Figure 1* allows the LM4816 to drive high efficiency, full range speaker whose response extends below 30Hz.

Bypass Capacitor Value Selection

Besides minimizing the input capacitor size, careful consideration should be paid to value of C_B , the capacitor connected to the BYPASS pin. Since C_B determines how fast the LM4816 settles to quiescent operation, its value is critical when minimizing turn-on pops. The slower the LM4816's outputs ramp to their quiescent DC voltage (nominally 1/2 V_{DD}), the smaller the turn-on pop. Choosing C_B equal to 1.0 μ F along with a small value of C_i (in the range of 0.1 μ F to 0.39 μ F), produces a click-less and pop-less shutdown function. As discussed above, choosing C_i no larger than necessary for the desired bandwidth helps minimize clicks and pops.

OPTIMIZING CLICK AND POP REDUCTION PERFORMANCE

The LM4816 contains circuitry to minimize turn-on and shutdown transients or "clicks and pop". For this discussion, turn-on refers to either applying the power supply voltage or when the shutdown mode is deactivated. While the power supply is ramping to its final value, the LM4816's internal amplifiers are configured as unity gain buffers. An internal current source changes the voltage of the BYPASS pin in a controlled, linear manner. Ideally, the input and outputs track

Application Information (Continued)

the voltage applied to the BYPASS pin. The gain of the internal amplifiers remains unity until the voltage on the bypass pin reaches $1/2 V_{DD}$. As soon as the voltage on the BYPASS pin is stable, the device becomes fully operational. Although the bypass pin current cannot be modified, changing the size of C_B alters the device's turn-on time and the magnitude of "clicks and pops". Increasing the value of C_B reduces the magnitude of turn-on pops. However, this presents a tradeoff: as the size of C_B increases, the turn-on time increases. There is a linear relationship between the size of C_B and the turn-on time. Here are some typical turn-on times for various values of C_B :

C_B	T_{ON}
0.01 μ F	20 ms
0.1 μ F	200 ms
0.22 μ F	440 ms
0.47 μ F	940 ms
1.0 μ F	2 Sec

In order eliminate "clicks and pops", all capacitors must be discharged before turn-on. Rapidly switching V_{DD} may not allow the capacitors to fully discharge, which may cause "clicks and pops".

NO LOAD STABILITY

The LM4816 may exhibit low level oscillation when the load resistance is greater than $10k\Omega$. This oscillation only occurs as the output signal swings near the supply voltages. Prevent this oscillation by connecting a $5k\Omega$ between the output pins and ground.

AUDIO POWER AMPLIFIER DESIGN

Audio Amplifier Design: Driving 1W into an 8 Ω Load

The following are the desired operational parameters:

Power Output:	1W _{RMS}
Load Impedance:	8 Ω
Input Level:	1V _{RMS}
Input Impedance:	20k Ω
Bandwidth:	100Hz–20 kHz \pm 0.25 dB

The design begins by specifying the minimum supply voltage necessary to obtain the specified output power. One way to find the minimum supply voltage is to use the Output Power vs Supply Voltage curve in the **Typical Performance Characteristics** section. Another way, using Equation (4), is to calculate the peak output voltage necessary to achieve the desired output power for a given load impedance. To account for the amplifier's dropout voltage, two additional voltages, based on the Dropout Voltage vs Supply Voltage in the **Typical Performance Characteristics** curves, must be added to the result obtained by Equation (8). The result in Equation (9).

$$V_{\text{opeak}} = \sqrt{(2R_L P_O)} \quad (8)$$

$$V_{DD} \geq (V_{\text{OUTPEAK}} + (V_{\text{ODTOP}} + V_{\text{ODBOT}})) \quad (9)$$

The Output Power vs Supply Voltage graph for an 8 Ω load indicates a minimum supply voltage of 4.6V. This is easily met by the commonly used 5V supply voltage. The additional voltage creates the benefit of headroom, allowing the LM4816 to produce peak output power in excess of 1W without clipping or other audible distortion. The choice of supply voltage must also not create a situation that violates maximum power dissipation as explained above in the **Power Dissipation** section.

After satisfying the LM4816's power dissipation requirements, the minimum differential gain is found using Equation (10).

$$A_{VD} \geq \sqrt{(P_O R_L)} / (V_{IN}) = V_{\text{orms}} / V_{\text{inrms}} \quad (10)$$

Thus, a minimum gain of 2.83 allows the LM4816's to reach full output swing and maintain low noise and THD+N performance. For this example, let $A_{VD} = 3$.

The amplifier's overall gain is set using the input (R_i) and feedback (R_f) resistors. With the desired input impedance set at 20k Ω , the feedback resistor is found using Equation (11).

$$R_f / R_i = A_{VD} / 2 \quad (11)$$

The value of R_f is 30k Ω .

The last step in this design example is setting the amplifier's -3dB frequency bandwidth. To achieve the desired $\pm 0.25\text{dB}$ pass band magnitude variation limit, the low frequency response must extend to at least one-fifth the lower bandwidth limit and the high frequency response must extend to at least five times the upper bandwidth limit. The gain variation for both response limits is 0.17dB, well within the $\pm 0.25\text{dB}$ desired limit. The results are an

$$f_L = 100\text{Hz} / 5 = 20\text{Hz} \quad (12)$$

and an

$$F_H = 20\text{kHz} \times 5 = 100\text{kHz} \quad (13)$$

As mentioned in the **External Components** section, R_i and C_i create a highpass filter that sets the amplifier's lower bandpass frequency limit. Find the coupling capacitor's value using Equation (14).

$$C_i \geq \frac{1}{2\pi R_i f_c} \quad (14)$$

the result is

$$1 / (2\pi \times 20\text{k}\Omega \times 20\text{Hz}) = 0.398\mu\text{F} \quad (15)$$

Use a 0.39 μ F capacitor, the closest standard value.

The product of the desired high frequency cutoff (100kHz in this example) and the differential gain, A_{VD} , determines the upper passband response limit. With $A_{VD} = 3$ and $f_H = 100\text{kHz}$, the closed-loop gain bandwidth product (GBWP) is 300kHz. This is less than the LM4816's 3.5MHz GBWP. With

Application Information (Continued)

this margin, the amplifier can be used in designs that require more differential gain while avoiding performance-restricting bandwidth limitations.

Physical Dimensions inches (millimeters) unless otherwise noted

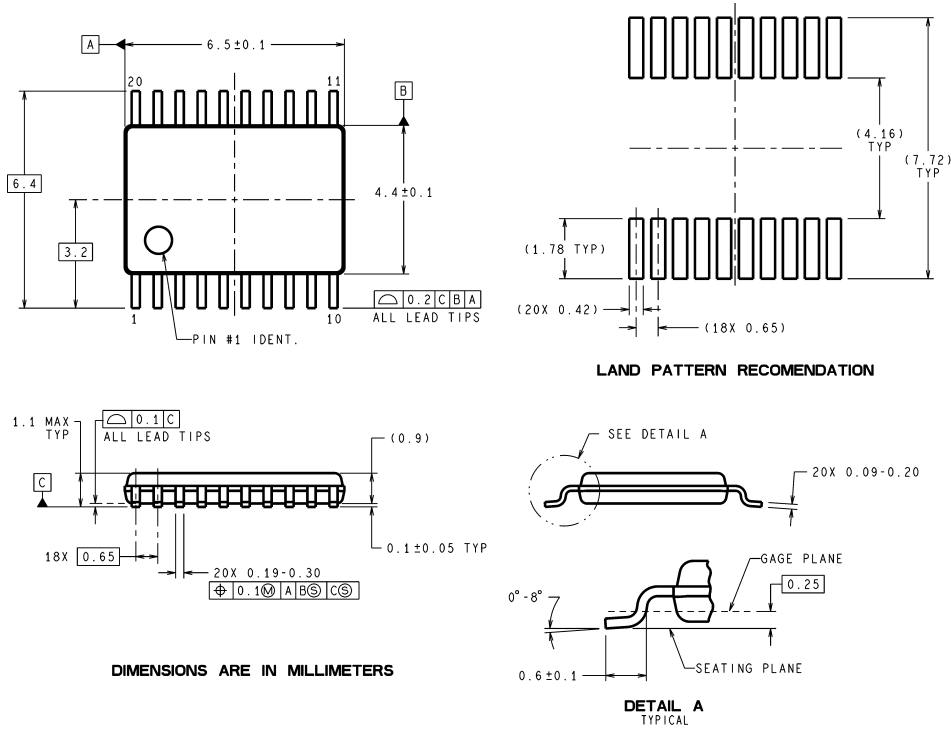

20-Lead Molded PKG, TSSOP, JEDEC, 4.4mm BODY WIDTH
Order Number LM4816MT
NS Package Number MTC20

MTC20 (Rev E)

LIFE SUPPORT POLICY

NATIONAL'S PRODUCTS ARE NOT AUTHORIZED FOR USE AS CRITICAL COMPONENTS IN LIFE SUPPORT DEVICES OR SYSTEMS WITHOUT THE EXPRESS WRITTEN APPROVAL OF THE PRESIDENT AND GENERAL COUNSEL OF NATIONAL SEMICONDUCTOR CORPORATION. As used herein:

1. Life support devices or systems are devices or systems which, (a) are intended for surgical implant into the body, or (b) support or sustain life, and whose failure to perform when properly used in accordance with instructions for use provided in the labeling, can be reasonably expected to result in a significant injury to the user.
2. A critical component is any component of a life support device or system whose failure to perform can be reasonably expected to cause the failure of the life support device or system, or to affect its safety or effectiveness.



National Semiconductor
Americas Customer
Support Center
 Email: new.feedback@nsc.com
 Tel: 1-800-272-9959

National Semiconductor
Europe Customer Support Center
 Fax: +49 (0) 180-530 85 86
 Email: europe.support@nsc.com
 Deutsch Tel: +49 (0) 69 9508 6208
 English Tel: +44 (0) 870 24 0 2171
 Français Tel: +33 (0) 1 41 91 8790

National Semiconductor
Asia Pacific Customer
Support Center
 Email: ap.support@nsc.com

National Semiconductor
Japan Customer Support Center
 Fax: 81-3-5639-7507
 Email: jpn.feedback@nsc.com
 Tel: 81-3-5639-7560

www.national.com